

Dimmable High Bay Detector 1-10V Dimming Control

Model:UM07 UM08 UM09

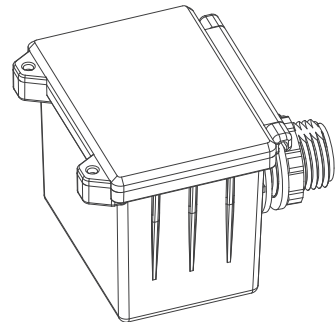
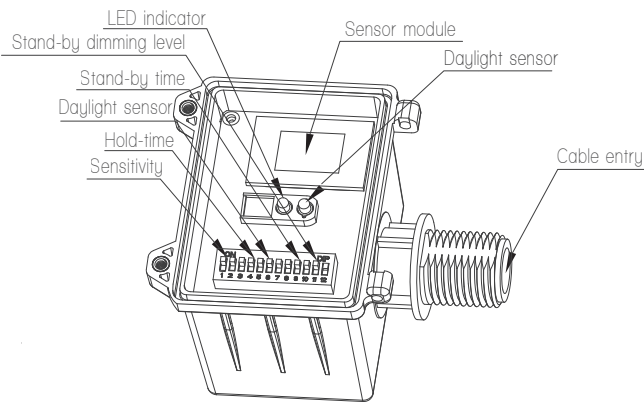

Mechanical structure (mm)

UM07

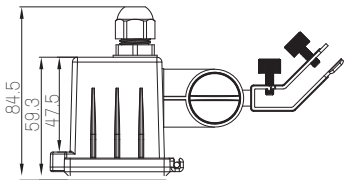
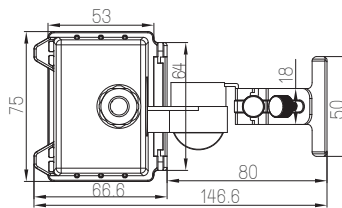

UM08

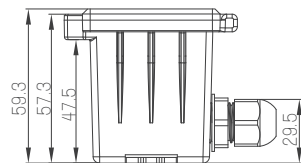
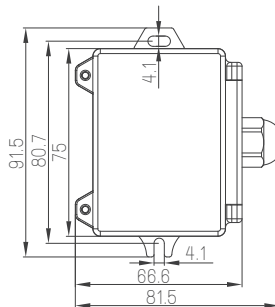

UM09

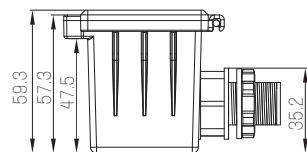
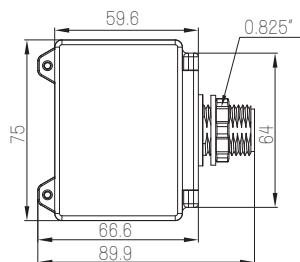

Product Feature

Step-dim function

The motion detector can turn on the light based on movement. With this detector built in, light is automatically on when needed and dimmed to preset level before it is totally off.

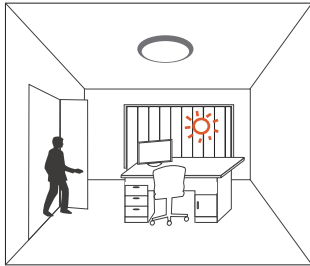

The light keeps off during daytime even when movement is detected. (Ambient lux level is above preset daylight threshold)

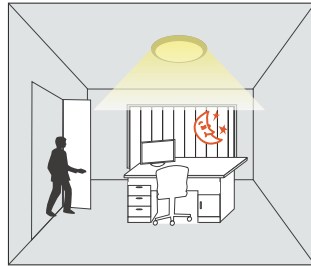

With movement and insufficient ambient lux level, the light is triggered on 100% by the detector.

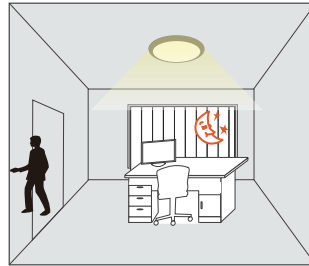

If there is no more movement, the light dims to stand-by dimming level after hold-time.

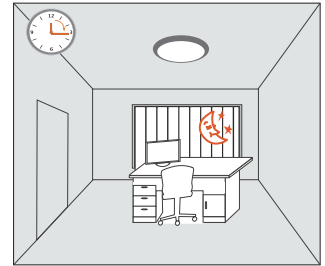

The light turns off automatically after stand-by time.

Wiring

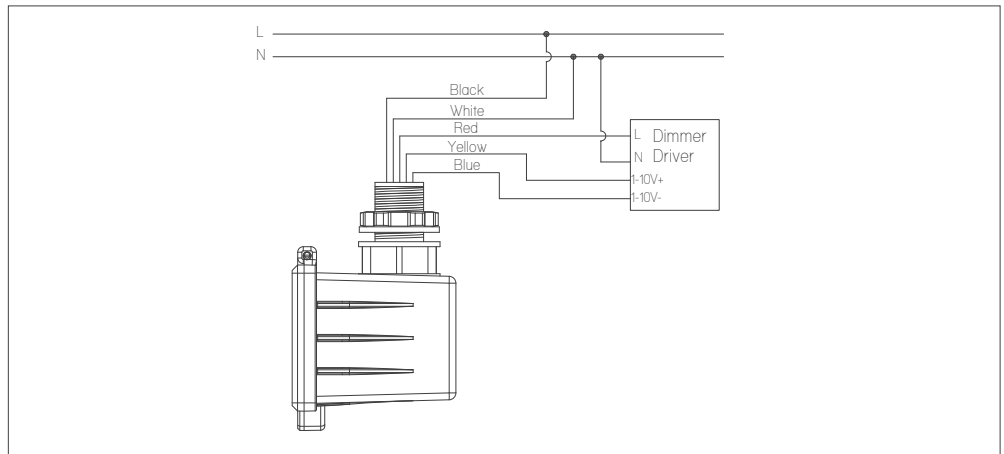

Detection pattern

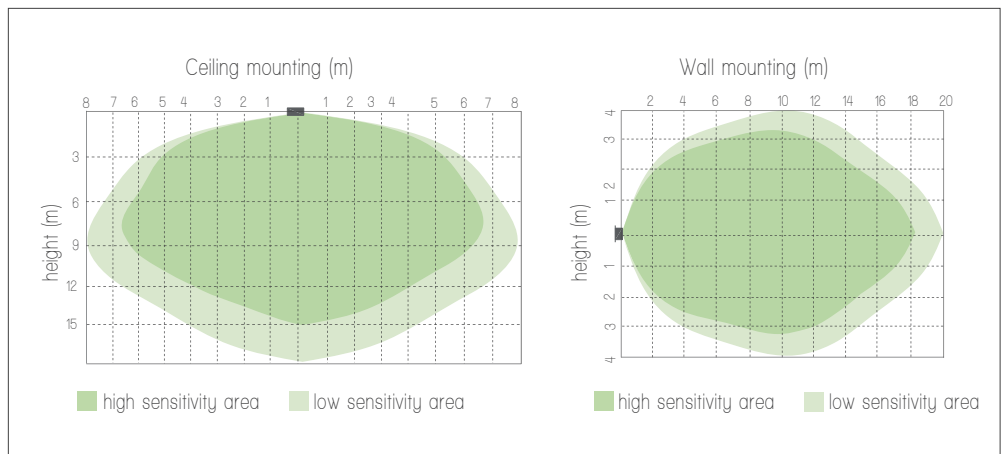

Settings

1. Sensitivity

Sensitivity can be adjusted by selecting the combination on the DIP switches for different applications.

- I – 100%
- II – 75%
- III – 50%
- IV – 10%



	1	2	
I	●	●	100%
II	●	○	75%
III	○	●	50%
IV	○	○	10%

2. Hold-time

Hold-time refers to the time period that the light remains 100% on if no more movement is detected.

- I – 5s
- II – 30s
- III – 1min
- IV – 5min
- V – 10min
- VI – 20min
- VII – 30min



	3	4	5	
I	●	●	●	5s
II	○	●	●	30s
III	●	○	●	1min
IV	●	●	○	5min
V	○	○	●	10min
VI	○	●	○	20min
VII	○	○	○	30min

3. Daylight threshold

Different daylight threshold can be preset on DIP switches. Light will always turn on upon movement if daylight sensor is disabled.

- I – Disable
- II – 50Lux
- III – 10Lux
- IV – 2Lux



	6	7	
I	●	●	Disable
II	●	○	50Lux
III	○	●	10Lux
IV	○	○	2lux

4. Stand-by time

This is the time period that the light remains at a low level before it is completely turned off.

- I – 0s
- II – 10s
- III – 1min
- IV – 5min
- V – 10min
- VI – 30min
- VII – 1h
- VIII – +∞



	8	9	10	
I	●	●	●	0s
II	○	●	●	10s
III	●	○	●	1min
IV	●	●	○	5min
V	○	○	●	10min
VI	○	●	○	30min
VII	●	○	○	1h
VIII	○	○	○	+∞

5. Stand-by dimming level

Light can be dimmed to different levels after hold-time.

- I – 10%
- II – 20%
- III – 30%
- IV – 50%



	11	12	
I	●	●	10%
II	●	○	20%
III	○	●	30%
IV	○	○	50%

Specification

Operating voltage	120 ~ 277VAC 50/60Hz
Rated load	400W @ 120VAC, 800W @ 277VAC (Capacitive load)
Stand-by power	<1W
Sensitivity	10% / 50% / 75% / 100%
Hold-time	5s / 30s / 1min / 5min / 10min / 20min / 30min
Stand-by time	0s / 10s / 1min / 5min / 10min / 30min / 1h / +∞
Stand-by dim level	10% / 20% / 30% / 50%
Daylight sensor	2 ~ 50lux, disable
Microwave frequency	5.8 GHz +/- 75MHz
Transmitting power	<1mW
Detection range	Max (diameter x height): 16m x 15m
Detection angle	30° ~ 150°
Working temperature	-20°C ~ +60°C
IP rating	IP65
Certificate	ETL , FCC